

N-Channel Power MOSFET

General Features

- $V_{DS} = 100V, I_D = 80A$
 $R_{DS(ON)} < 9m\Omega @ V_{GS} = 10V$
- Special process technology for high ESD capability
- High density cell design for ultra low R_{dson}
- Fully characterized avalanche voltage and current
- Good stability and uniformity with high E_{AS}
- Excellent package for good heat dissipation

Application

- Power switching application
- Hard switched and high frequency circuits
- Uninterruptible power supply

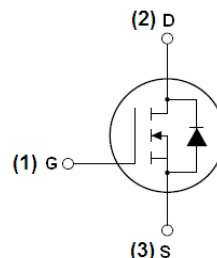

Schematic diagram

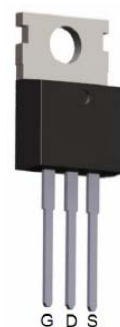

TO-220-3L top view

Absolute Maximum Ratings ($T_C = 25^\circ C$ unless otherwise noted)

Symbol	Parameter	Limit	Unit
V_{DS}	Drain-Source Voltage	100	V
V_{GS}	Gate-Source Voltage	± 20	V
I_D	Drain Current-Continuous	80	A
$I_D(100^\circ C)$	Drain Current-Continuous($T_C = 100^\circ C$)	70.7	A
I_{DM}	Pulsed Drain Current	350	A
P_D	Maximum Power Dissipation	188	W
	Derating factor	1.33	W/ $^\circ C$
E_{AS}	Single pulse avalanche energy ^(Note 5)	61	mJ
T_J, T_{STG}	Operating Junction and Storage Temperature Range	-55 To 175	$^\circ C$

Thermal Characteristic

$R_{\theta JC}$	Thermal Resistance, Junction-to-Case ^(Note 2)	0.8	$^{\circ}C/W$
-----------------	--	-----	---------------

Electrical Characteristics ($T_C=25^{\circ}C$ unless otherwise noted)

Symbol	Parameter	Condition	Min	Typ	Max	Unit
Off Characteristics						
BV_{DSS}	Drain-Source Breakdown Voltage	$V_{GS}=0V, I_D=250\mu A$	100	-	-	V
I_{DSS}	Zero Gate Voltage Drain Current	$V_{DS}=100V, V_{GS}=0V$	-	-	1	μA
I_{GSS}	Gate-Body Leakage Current	$V_{GS}=\pm 20V, V_{DS}=0V$	-	-	± 100	nA
On Characteristics ^(Note 3)						
$V_{GS(th)}$	Gate Threshold Voltage	$V_{DS}=V_{GS}, I_D=250\mu A$	1.2	-	2.3	V
$R_{DS(ON)}$	Drain-Source On-State Resistance	$V_{GS}=10V, I_D=40A$	-	6.6	9	m Ω
g_{FS}	Forward Transconductance	$V_{DS}=50V, I_D=40A$	-	85	-	S
Dynamic Characteristics ^(Note 4)						
C_{iss}	Input Capacitance	$V_{DS}=50V, V_{GS}=0V,$ $F=1.0MHz$	-	3320	-	PF
C_{oss}	Output Capacitance		-	605	-	PF
C_{rss}	Reverse Transfer Capacitance		-	20	-	PF
Switching Characteristics ^(Note 4)						
$t_{d(on)}$	Turn-on Delay Time	$V_{DD}=50V, I_D=40A$ $V_{GS}=10V, R_{GEN}=2.5\Omega$	-	10	-	nS
t_r	Turn-on Rise Time		-	6.5	-	nS
$t_{d(off)}$	Turn-Off Delay Time		-	45	-	nS
t_f	Turn-Off Fall Time		-	7.5	-	nS
Q_g	Total Gate Charge	$V_{DS}=80V, I_D=40A,$ $V_{GS}=10V$	-	45	-	nC
Q_{gs}	Gate-Source Charge		-	9.5	-	nC
Q_{gd}	Gate-Drain Charge		-	4.8	-	nC
Drain-Source Diode Characteristics						
V_{SD}	Diode Forward Voltage ^(Note 3)	$V_{GS}=0V, I_S=40A$	-	-	1.2	V
I_S	Diode Forward Current ^(Note 2)	-	-	-	57	A
t_{rr}	Reverse Recovery Time	$T_J = 25^{\circ}C, I_F = 40A$ $di/dt = 100A/\mu s$ (Note 3)	-	18.6	-	nS
Q_{rr}	Reverse Recovery Charge		-	65	-	nC
t_{on}	Forward Turn-On Time	Intrinsic turn-on time is negligible (turn-on is dominated by LS+LD)				

Note :

1. The data tested by surface mounted on a 1 inch² FR-4 board with 2OZ copper.
2. The data tested by pulsed , pulse width $\leq 300\mu s$, duty cycle $\leq 2\%$
3. The EAS data shows Max. rating . The test condition is $V_{DD}=25V, V_{GS}=10V, L=0.3mH, I_{AS}=35A$
4. The power dissipation is limited by junction temperature
5. The data is theoretically the same as I_D and I_{DM} , in real applications , should be limited by total power dissipation.
6. The maximum current rating is package limited.

Typical Characteristics

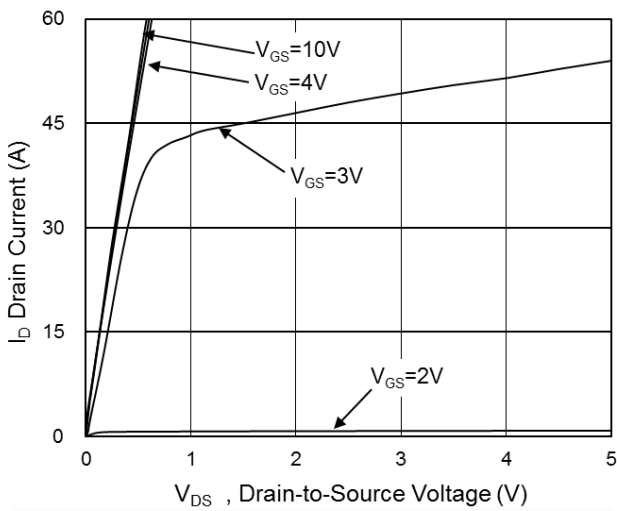

Fig.1 Typical Output Characteristics

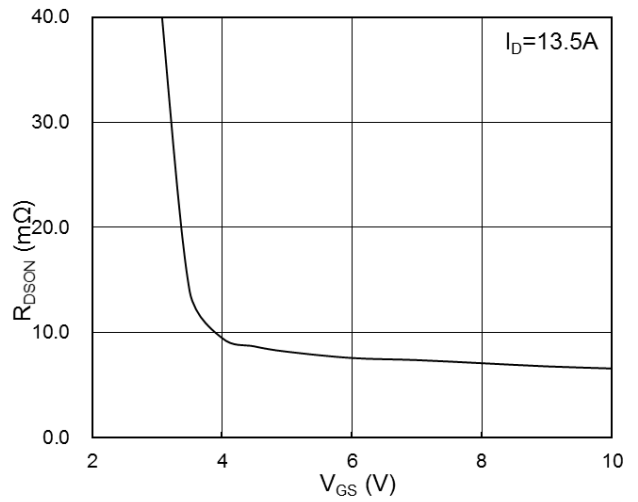

Fig.2 On-Resistance vs. G-S Voltage

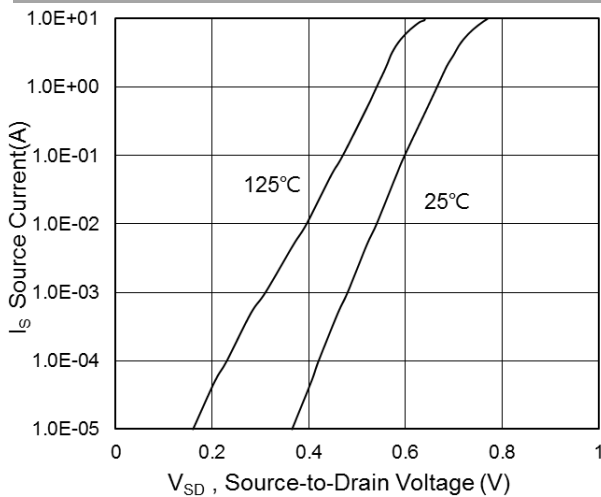

Fig.3 Source-Drain Forward Characteristics

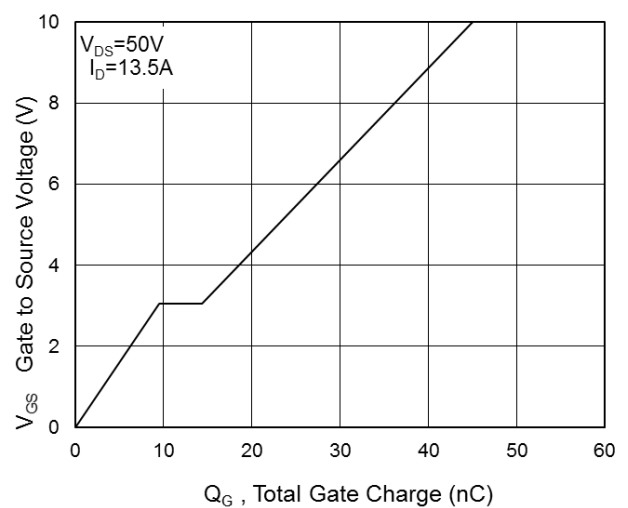

Fig.4 Gate-Charge Characteristics

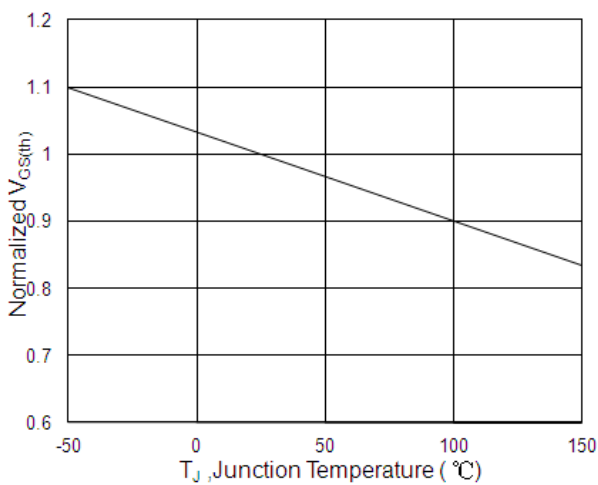

Fig.5 Normalized $V_{GS(th)}$ vs. T_J

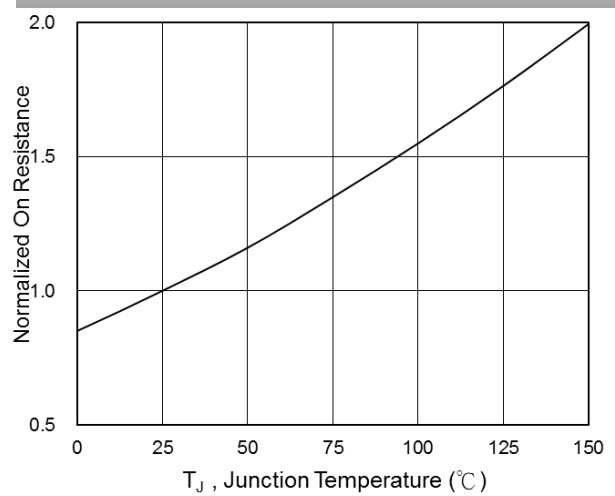

Fig.6 Normalized R_{DSON} vs. T_J

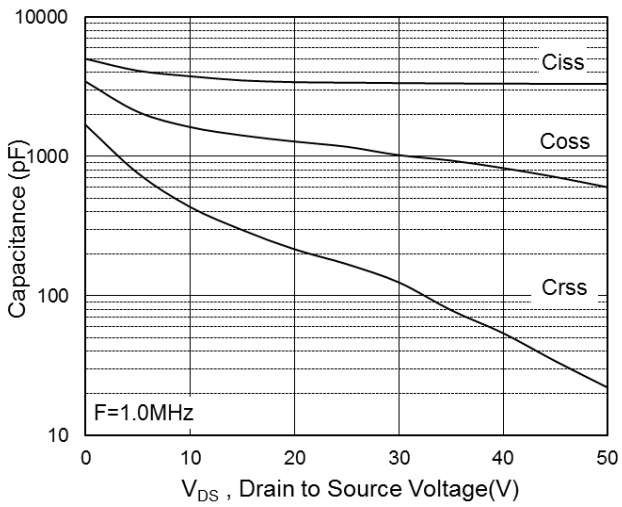

Fig.7 Capacitance

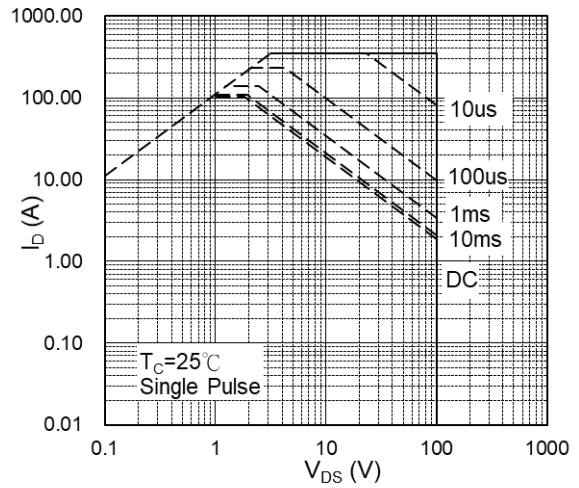

Fig.8 Safe Operating Area

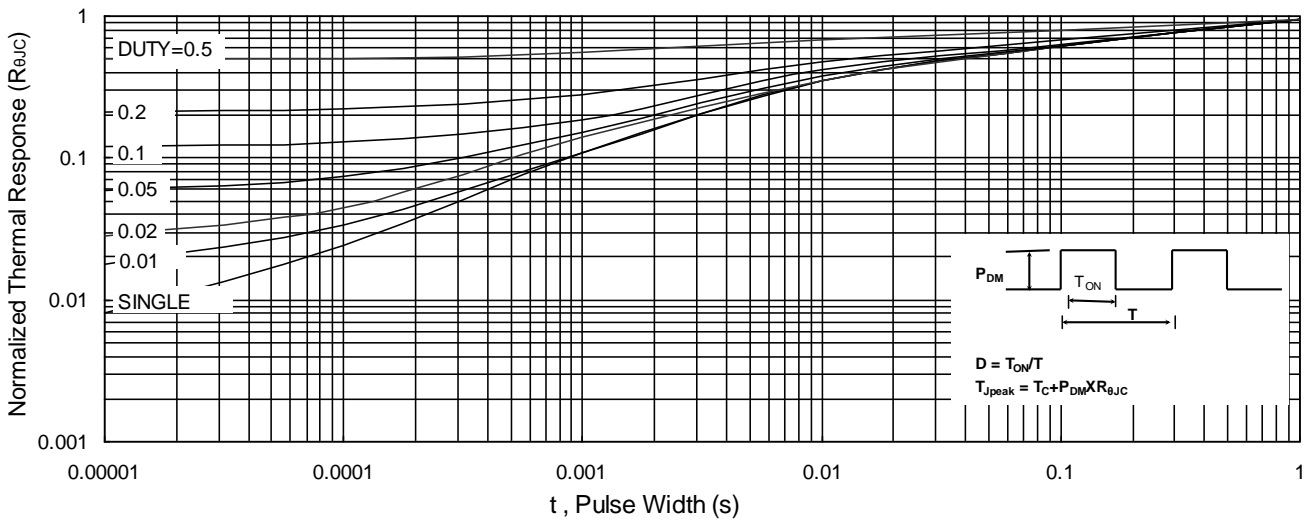

Fig.9 Normalized Maximum Transient Thermal Impedance

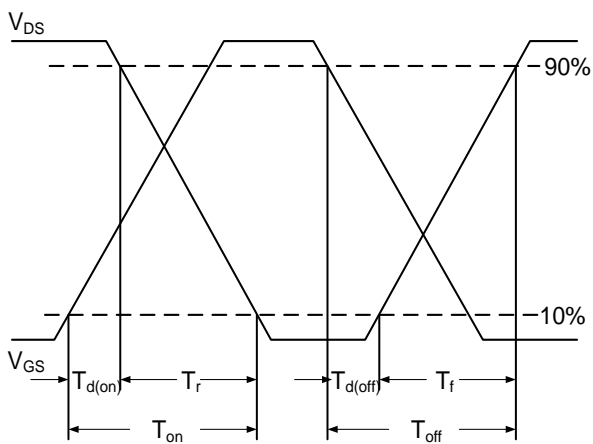

Fig.10 Switching Time Waveform

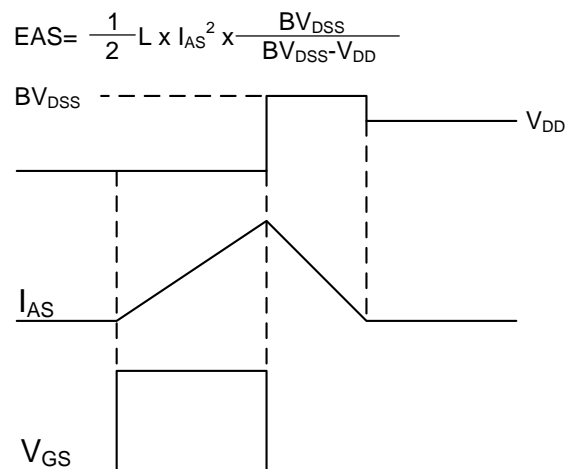
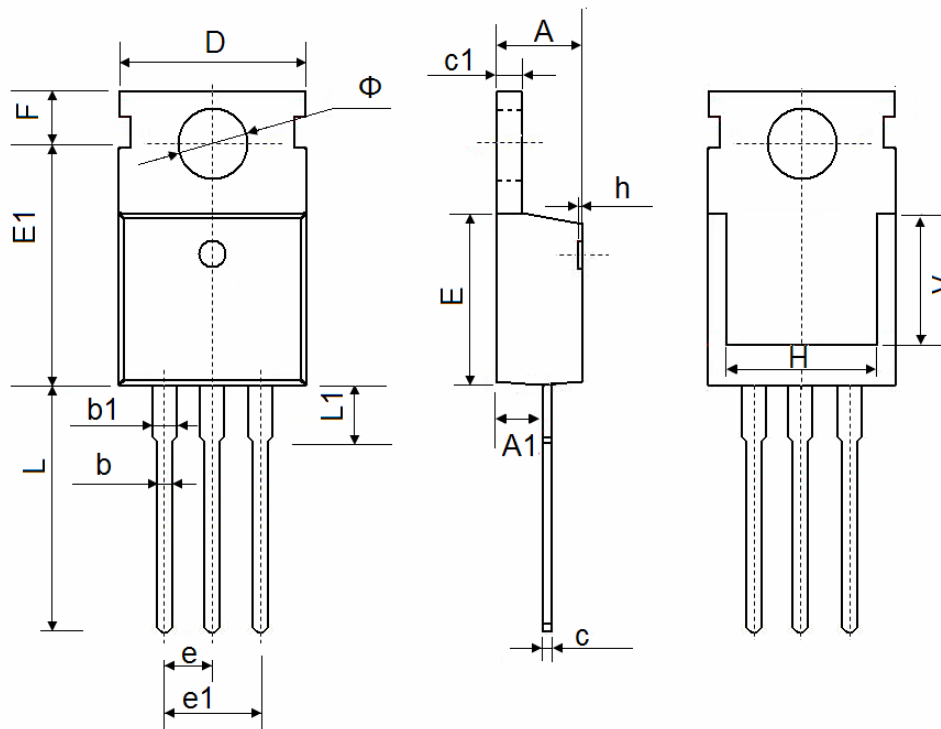

Fig.11 Unclamped Inductive Switching Waveform

TO-220-3L Package Information



Symbol	Dimensions In Millimeters		Dimensions In Inches	
	Min.	Max.	Min.	Max.
A	4.400	4.600	0.173	0.181
A1	2.250	2.550	0.089	0.100
b	0.710	0.910	0.028	0.036
b1	1.170	1.370	0.046	0.054
c	0.330	0.650	0.013	0.026
c1	1.200	1.400	0.047	0.055
D	9.910	10.250	0.390	0.404
E	8.9500	9.750	0.352	0.384
E1	12.650	12.950	0.498	0.510
e	2.540 TYP.		0.100 TYP.	
e1	4.980	5.180	0.196	0.204
F	2.650	2.950	0.104	0.116
H	7.900	8.100	0.311	0.319
h	0.000	0.300	0.000	0.012
L	12.900	13.400	0.508	0.528
L1	2.850	3.250	0.112	0.128
V	7.500 REF.		0.295 REF.	
Φ	3.400	3.800	0.134	0.150