

N-Channel Enhancement Mode Power MOSFET

Description

This Power MOSFET is produced using advanced TRENCH technology. This advanced technology has been especially tailored to minimize conduction loss, provide superior switching performance, and withstand high energy pulse in the avalanche and commutation mode.

Features

- $V_{DS}=30V$, $I_D=160A$
- $R_{DS(ON) TYP} = 1.5m\Omega @ V_{GS} = 10V$
- $R_{DS(ON) TYP} = 2.2m\Omega @ V_{GS} = 4.5V$
- Very Low On-resistance $R_{DS(ON)}$
- Low C_{rSS}
- Fast switching
- 100% avalanche tested
- Improved dv/dt capability

PDFN5*6-8L

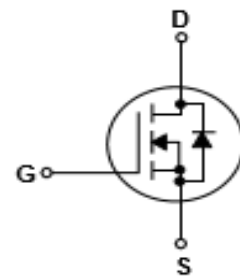
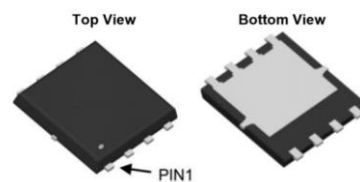

Schematic

Applications

- PWM Application
- Load Switch
- Power Management

100% UIS TESTED!

100% ΔV_{ds} TESTED!



Package Marking and Ordering Information

Device	Marking	Package	Packing	Reel (pcs)
SL160N03R		PDFN5*6	Reel	5000

Absolute Maximum Ratings

Parameter		Symbol	Value	Unit
Drain-source Voltage		V_{DS}	30	V
Gate-source Voltage		V_{GS}	± 20	V
Continuous Drain Current	$T_C=25^{\circ}C$	I_D	160	A
	$T_C=100^{\circ}C$		104	
Pulsed Drain Current($T_C=25^{\circ}C, T_p$ Limited By T_{jmax}) ^(note1)		I_{DM}	640	A
Maximum Power Dissipation($T_C=25^{\circ}C$)		P_D	50	W
Avalanche energy , single Pulse($L=0.5mH$) ^(note2)		E_{AS}	870	mJ
Peak Diode Recovery dv/dt ^(note3)		dv/dt	4.5	V/ns
Thermal Resistance Junction to Case		$R_{\theta JC}$	2.5	$^{\circ}C/W$
Operating Junction And Storage Temperature		T_j, T_{stg}	-55 To 150	$^{\circ}C$
Maximum lead temperature for soldering purposes, 1/8" from case for 5 seconds		T_L	300	$^{\circ}C$

* Drain current limited by maximum junction temperature.

Notes:

1. Repetitive Rating: Pulse Width Limited by Maximum Junction Temperature
2. EAS condition: $T_J = 25^{\circ}C$, $V_{DD} = 15V$, $V_G = 10V$, $R_G = 25 \Omega$, $L = 0.5mH$,
3. Pulse Test: Pulse Width $\leq 300 \mu s$, Duty Cycle $\leq 0.5\%$

Electrical Characteristic (TC=25°C unless otherwise noted)

Parameter	Symbol	Value			Unit	Test Condition
		Min.	Typ.	Max.		
Off Characteristic						
Drain-source breakdown voltage	BV_{DSS}	30	-	-	V	$V_{GS}=0V, I_D=250\mu A$
Zero gate voltage drain current	I_{DSS}	-	-	1	μA	$V_{DS}=30V, V_{GS}=0V$
		-	-	50	μA	$V_{DS}=24V, TC=125^\circ C$
Gate-source leakage current	I_{GSS}	-	-	± 100	nA	$V_{GS}=\pm 20V, V_{DS}=0V$
On Characteristics						
Gate threshold voltage	$V_{GS(th)}$	1.0	1.6	2.2	V	$V_{DS}=V_{GS}, I_D=250\mu A$
Drain-source on-state resistance	$R_{DS(on)}$	-	1.5	2.0	m Ω	$V_{GS}=10V, I_D=20A$
Dynamic Characteristic						
Input Capacitance	C_{iss}	-	7710	-	PF	$V_{GS}=0V, V_{DS}=30V, f=1.0MHz$
Output Capacitance	C_{oss}	-	845	-		
Reverse Transfer Capacitance	C_{rss}	-	838	-		
Switching Characteristics						
Turn-on delay time	$t_{d(on)}$	-	18	-	nS	$V_{GS}=10V, V_{DS}=30V, I_D=30A, R_G=25\Omega$
Turn-on Rise time	t_r	-	10	-		
Turn-off delay time	$t_{d(off)}$	-	64	-		
Turn-off Fall time	t_f	-	16	-		
Gate Total Charge	Q_G	-	142	-	nC	$V_{GS}=10V, V_{DS}=30V, I_D=30A$
Gate-Source Charge	Q_{gs}	-	92	-		
Gate-Drain Charge	Q_{gd}	-	18	-		
Drain-Source Diode Characteristics						
Body Diode Forward Voltage	V_{SD}	-	-	1.2	V	$V_{GS}=0V, I_{SD}=20A, T_J=25^\circ C$
Body Diode Forward Current	I_S	-	-	160	A	-
Body Diode Reverse Recovery Time	T_{rr}	-	30	-	ns	$T_J=25^\circ C, I_{SD}=20A, V_{GS}=0V, di/dt=100A/\mu s$
Body Diode Reverse Recovery Charge	Q_{rr}	-	22	-	nC	

N- Channel Typical Characteristics

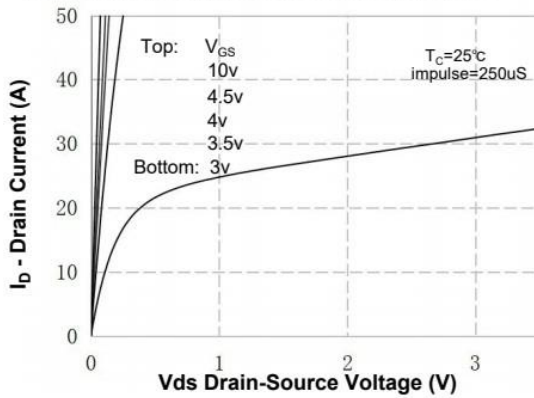

Figure 1. On-Region Characteristics

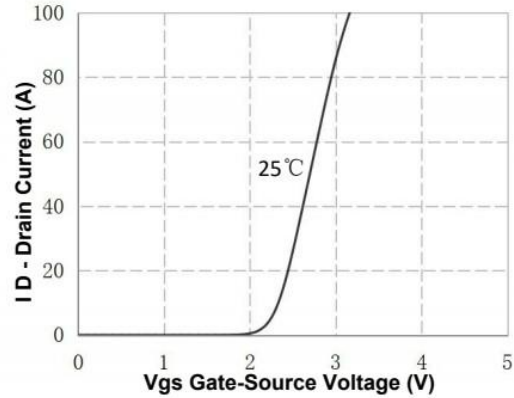

Figure 2. Transfer Characteristics

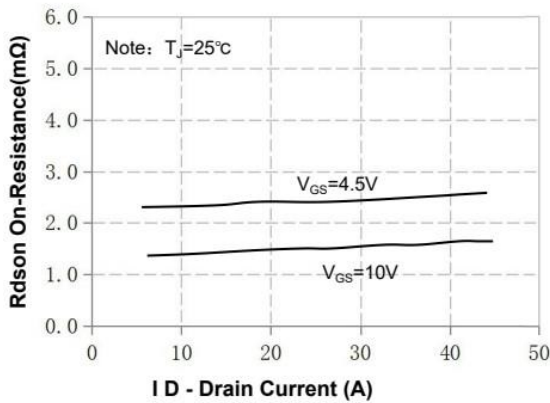

Figure 3. On-Resistance Variation vs Drain Current and Gate Voltage

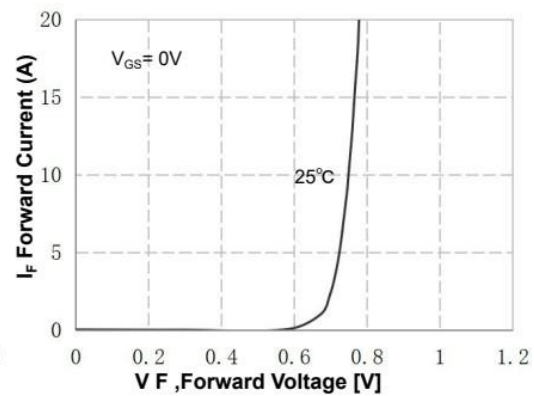

Figure 4. Body Diode Forward Voltage Variation with Source Current and Temperature

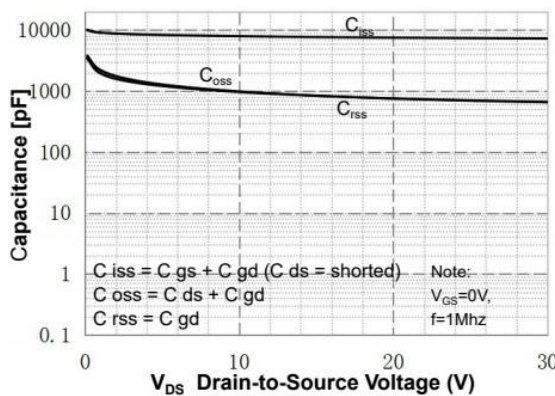

Figure 5. Capacitance Characteristics

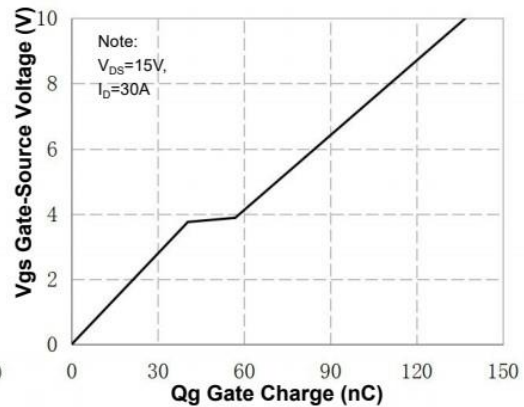

Figure 6. Gate Charge Characteristics

N-Channel Typical Characteristics (Continued)

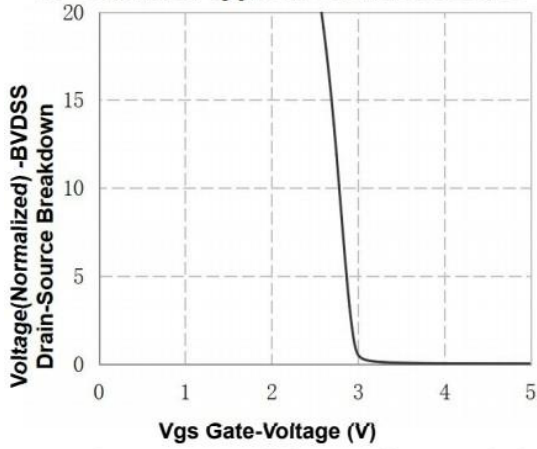

Figure 7. Breakdown Voltage Variation vs Gate-Voltage

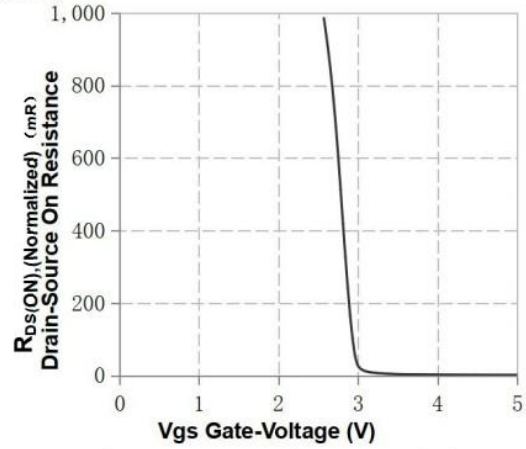

Figure 8. On-Resistance Variation vs Gate Voltage

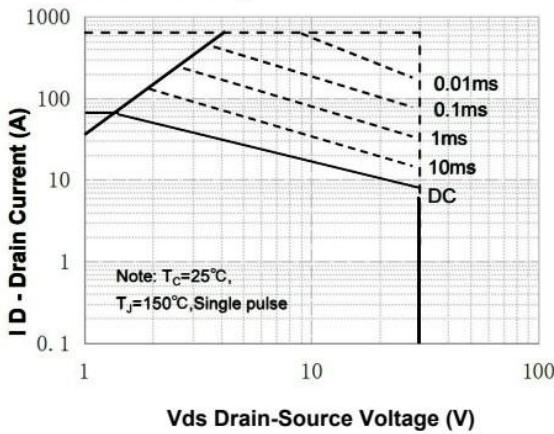

Figure 9. Maximum Safe Operating Area

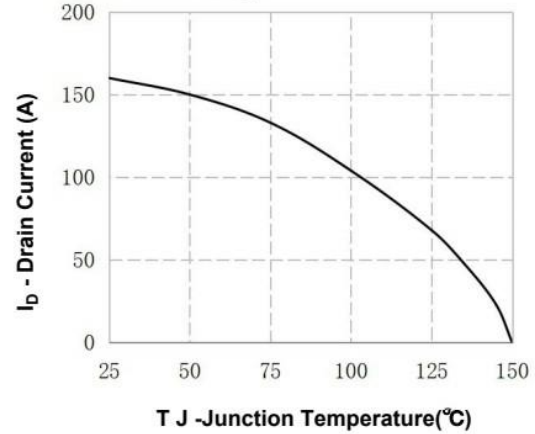

Figure 10. Maximum PContinuous Drain Current vs Case Temperature

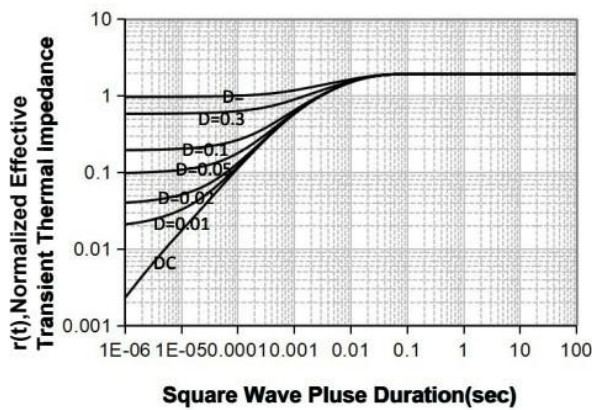
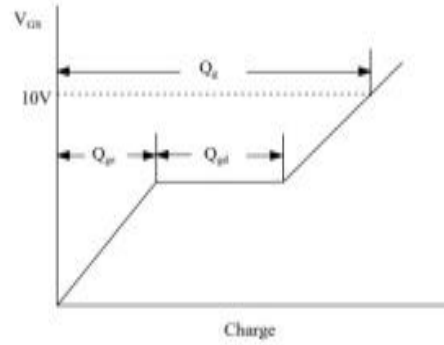
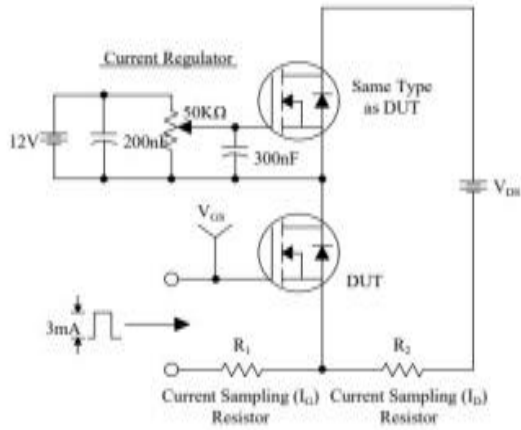
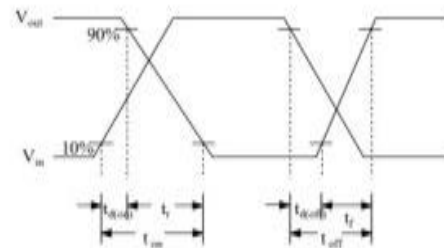
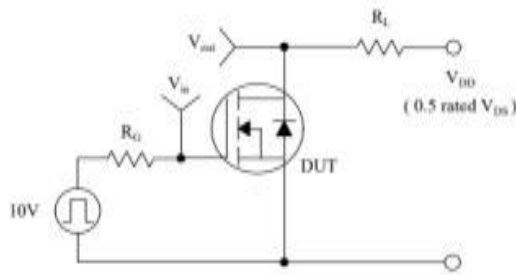

Figure 11. Transient Thermal Response Curve

Gate Charge Test Circuit & Waveform



Resistive Switching Test Circuit & Waveforms



Unclamped Inductive Switching Test Circuit & Waveforms

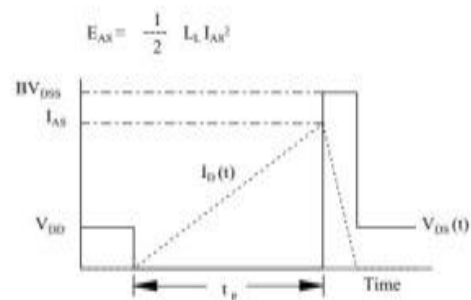
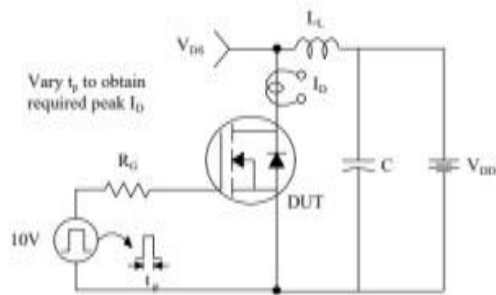

Peak Diode Recovery dv/dt Test Circuit & Waveforms

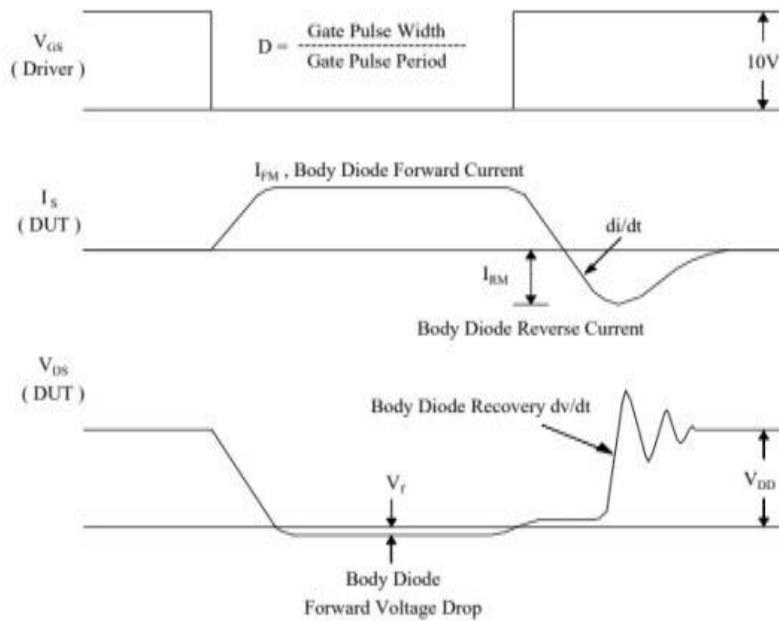
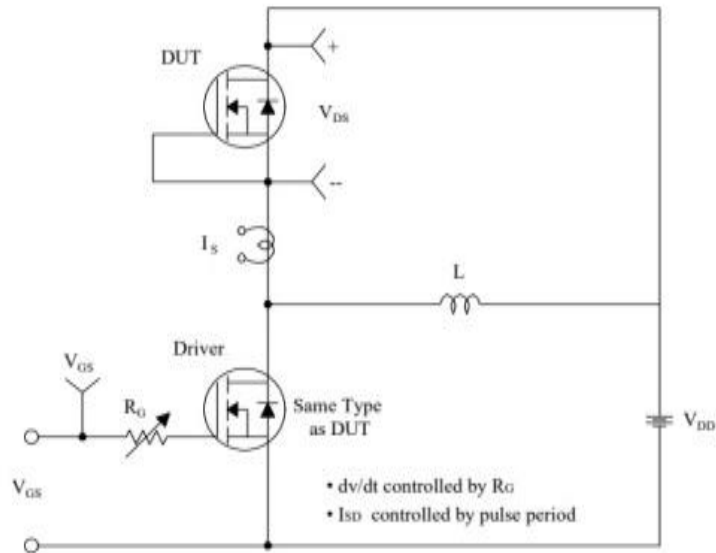

Package Information

PDFN5*6-8L

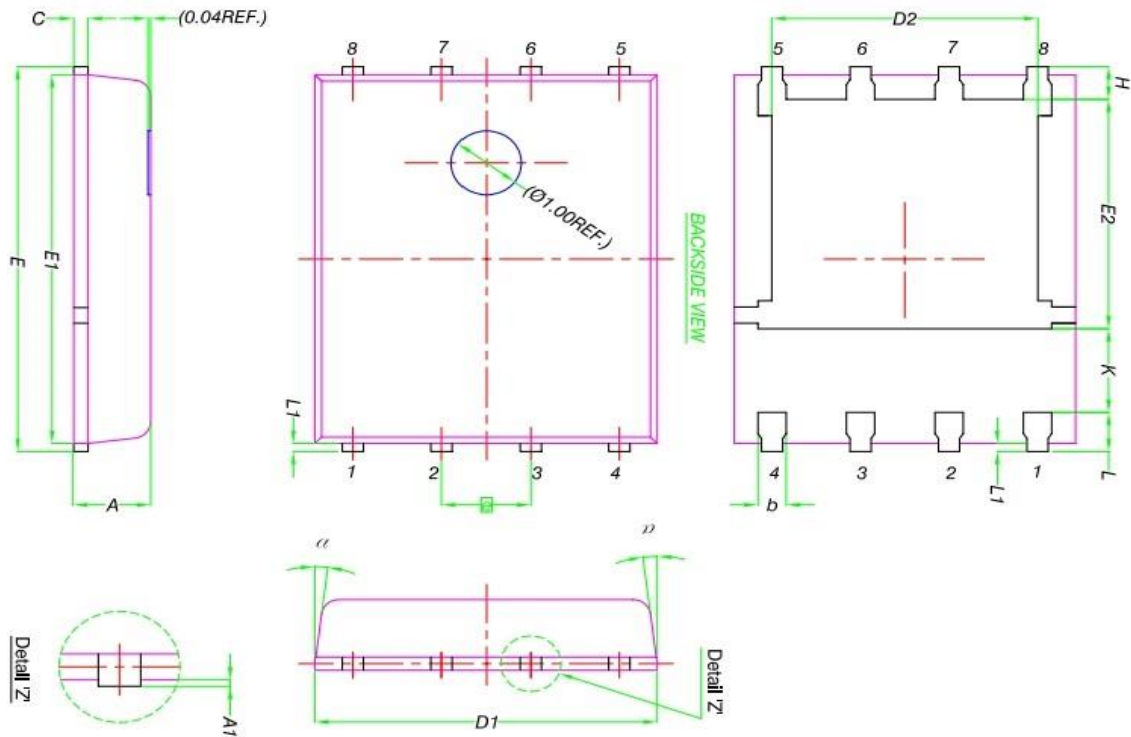

DIM.	MILLIMETERS		
	MIN.	NOM.	MAX.
A	0.90	1.00	1.10
A1	0	-	0.05
b	0.33	0.41	0.51
C	0.20	0.25	0.30
D1	4.80	4.90	5.00
D2	3.61	3.81	3.96
E	5.90	6.00	6.10
E1	5.70	5.75	5.80
E2	3.38	3.58	3.78
e	1.27 BSC		
H	0.41	0.51	0.61
K	1.10	-	-
L	0.51	0.61	0.71
L1	0.06	0.13	0.20
α	0°	-	12°

